

Fuseal® Corrosive Waste Piping Systems



NEW
Fast-Lock™
Mechanical
Joint System



Fuseal® Fast-Lock™

Mechanical Joint Polypropylene Special Waste Piping System

Patent Pending

Fuseal® Fast-Lock™ PP Benefits

GF is introducing a revolutionary new mechanical joint (MJ) system for special waste drainage systems: Fuseal Fast-Lock. The new fittings will be available in sizes 1-1/2" – 4", in Fuseal polypropylene flame retardant and will work with both FR and non-flame retardant pipes. Enjoy all the standard features of GF's Fuseal piping system, with the new benefits of a truly innovative Fast-Lock system.



Contact us

Tel. (714) 731-8800, Toll Free (800) 854-4090
Fax (714) 731-6201
us.ps@georgfischer.com
www.gfpiping.com

Fast installation

The Fast-Lock System is fast and easy to install. Unlike cemented systems, it does not require special cement or applicators nor are there any toxic fumes. Most importantly there are no cure times to wait for, which can be hours or days. The Fast-Lock system is immediately ready for operation.

Compact

Our new mechanical system is the most compact mechanical joint on the market. It allows for installation of the system in tight spaces such as between walls where other systems will not fit.

No special Tools

The Fast-Lock system collar simply requires an 8 or 10mm socket driver. A standard ratchet and socket can be used as well as cordless drivers. No grooving tools are required.

Pressure rated

The system is rated for 35 psi. Just like the Fuseal electrofusion system, this is a necessary property for vacuum and pumped drainage systems that have intermittent pressure requirements.

Modular

The Fuseal Fast-Lock and electrofusion systems have interchangeable collars allowing for easy integration of the two designs. Any fitting can become a transition from electrofusion to the mechanical joint or vice versa.



Fuseal® polypropylene piping system

Easy and reliable solution for corrosive waste piping systems

Excellent corrosion, chemical, and environment resistance

Fuseal PP is resistant to the corrosive action of alkalis, alcohols, acids, solvents and salt solutions. Dilute mineral acids and aqueous solutions of acid salts, which are destructive to most metals, have no effect on the Fuseal PP system. In general, Fuseal PP is attacked only by strong oxidizing acids and weakened by certain organic solvents and chlorinated hydrocarbons. Fuseal PP will not rust, pit, scale, corrode or be affected by electrolysis.

Fuseal PP piping systems have excellent chemical resistance and physical properties which make the system ideal for handling corrosive waste mixtures of acids, bases and solvents present in laboratory, industrial or food and beverage processing DWV applications.

In above ground installations, the pigmentation protects the system from sunlight. The pigmentation is highly resistant to ultraviolet radiation and is heat-stabilized to provide long life while handling hot reagents.

High temperature rating

Fuseal handles corrosive drainage fluids up to 212°F (100°C) intermittently, continuous service up to 180°F (82°C).

Applications

Excellent chemical and physical properties make the Fuseal PP system ideal for handling corrosive chemical waste solutions present in laboratory and industrial DWV applications. Fuseal PP is suitable for use in chemical and industrial plants as well as in food and beverage, hospital and university laboratories, anywhere mixtures of acids, bases and solvents are drained. Fuseal PP is replacing many metallic waste systems that are failing due to corrosion.



Fuseal® benefits

- Low installation cost with maintenance-free service
- Chemical and corrosion resistance
- Flame retardant PP (above grade), non-flame retardant PP (below grade)
- High temperature, intermittent discharges up to 212°F (100°C), continuous up to 180°F (82°C)
- Can be used for pressurized drainage applications up to 50 psi (35 psi for Fast-Lock)
- Both electrofusion and mechanical joints
- Easy-to-operate, highly reliable electrofusion machines

Fields of application

- Corrosive waste drainage
- Life sciences
- Chemical process industry
- Shipbuilding/marine
- Food and beverage

Product range

Fittings	Connection	Size	Material
Fuseal	New electrofusion locking collar	1½"–6"	Flame retardant polypropylene
Fuseal LD	Electrofusion loose coil	8"–14"	Flame retardant and non flame retardant polypropylene
Fuseal Fast-Lock MJ	Butt fusion	16"–18"	
	Mechanical joint	1½"–4"	Flame retardant polypropylene
Pipes		Size	Material
Schedule 40		1½"–12"	Flame retardant polypropylene
Schedule 40		1½"–18"	Non flame retardant polypropylene
Schedule 80		1½"–12"	Non flame retardant polypropylene

Electrofusion process

Electrofusion is defined as the joining process where two plastic parts are fused utilizing electrical heat resistance to form a permanent joint. A plastic coated copper wire is wound into a coil and is then inserted into a fitting socket. The pipe is then inserted into the fitting socket and an electric current is applied to the coil, producing heat that generates sufficient temperatures to melt the surrounding plastic and create a "melt zone." Fusion occurs when the joint cools below the melt temperature of the plastic material, leaving a permanent joint that is proven to be as strong as, if not stronger than, the individual components.



Fuseal Fast-Lock

The revolutionary new Fast-Lock system is easier than ever to install and has several advantages over other systems.

- **Fast installation** - The Fast-Lock System is fast and easy to install. Unlike cemented systems, it does not require special cement or applicators nor are there any toxic fumes. Most importantly there are no cure times to wait for. The Fuseal Fast-Lock system is immediately ready for pressure test and operation.
- **Compact** - Our new mechanical system is the most compact mechanical joint on the market. It allows for installation of the system in tight spaces such as between walls where other systems will not fit.
- **No special tools** - The Fast-Lock system collar simply requires an 8 or 10mm socket driver. A standard ratchet and socket can be used as well as cordless drivers. No grooving tools are required.
- **Pressure rated** - The system is rated for 35 psi. Just like the Fuseal® electrofusion system, this is a necessary property for vacuum and pumped drainage systems that have intermittent pressure requirements.
- **Modular** - The Fuseal Fast-Lock and electrofusion systems have interchangeable collars allowing for easy integration of the two. Any fitting can become a transition from electrofusion to the mechanical joint or vice versa.

Electro Plus fusion machine



Electro Plus® fusion machine

- Intuitive user interface
- Multiple joint capability for speedy installations
- Integral carrying case for ease of transportation
- Network and generator compatible for simple operation
- Self-diagnostic system takes the guesswork out of error detection
- Automatic compensation for ambient temperature
- One-button repeat fusion cycle for same size joints
- Used to install Fuseal PP, Fuseal 25/50, Fuseal Squared special waste piping systems as well as PPro-Seal™ natural PP process water piping systems

Fuseal fusion locking collar

The rotatable collar which contains the electrofusion coil, has been strengthened and now locks in place. The coil and its electrical connector still rotate for convenience, but can better handle the tough conditions during installation in the field. The many improved benefits include:

- Strengthened coil
- Locking groove on fitting hub
- Four tabs molded into collar locks into the grooves on fitting hub to resist axial motion while allowing for 360° collar rotation.
- Four slots allow visual confirmation of collar location on fitting.



Table of contents

Fuseal PPFR & PPNFR Pipe (Flame Retardant and Non-Flame Retardant)	6
Fuseal Fittings	8
Fuseal Cleanouts & Floor Drains PPFR	32
Fuseal Traps PPFR	36
Fuseal LD Fusion Fittings PP	46
Fuseal Fusion Accessories	51
Fuseal Fast-Lock Accessories	55

Fuseal PPRF & PPNFR Pipe (Flame Retardant and Non-Flame Retardant)

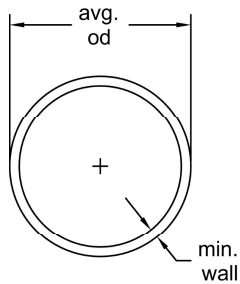

Schedule 40 PPRF

1 1/2" - 6" Available in 20' lengths upon request

Size (inch)	lengths (ft)	Code	Lift Qty (ft)	avg. od (inch)	min. wall (inch)
1 1/2	10	37A013015	1800	1.900	0.145
2	10	37A013020	1050	2.375	0.154
3	10	37A013030	580	3.500	0.216
4	10	37A013040	510	4.500	0.237
6	10	37A013060	220	6.625	0.280
8	20	37A023080	280	8.625	0.322
10	20	37A023100	220	10.750	0.365
12	20	37A023120	100	12.750	0.406

Schedule 40 PPNFR

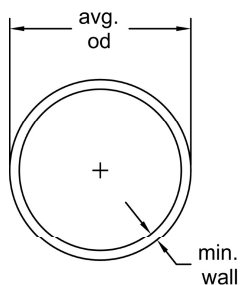

Size (inch)	lengths (ft)	Code	Lift Qty (ft)	avg. od (inch)	min. wall (inch)
1 1/2	20	37B023015	3600	1.900	0.145
2	20	37B023020	2100	2.375	0.154
3	20	37B023030	1160	3.500	0.216
4	20	37B023040	1020	4.500	0.237
6	20	37B023060	440	6.625	0.280
8	20	37B023080	280	8.625	0.322
10	20	37B023100	220	10.750	0.365
12	20	37B023120	100	12.750	0.406
14	20	37B023140	100	14.000	0.437
16	20	37B023160	100	16.000	0.500
18	20	37B023180	60	18.000	0.562



Schedule 80 PPNFR

Size (inch)	lengths (ft)	Code	Lift Qty (ft)	avg. od (inch)	min. wall (inch)
1 ½	20	37B021015	3600	1.900	0.200
2	20	37B021020	2100	2.375	0.281
3	20	37B021030	1160	3.500	0.300
4	20	37B021040	1020	4.500	0.337
6	20	37B021060	440	6.625	0.432
8	20	37B021080	280	8.625	0.500
10	20	37B021100	220	10.750	0.593
12	20	37B021120	100	12.750	0.687

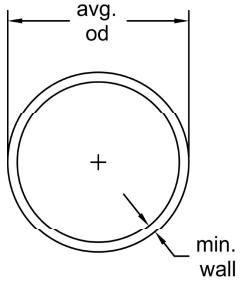

Fuseal Fittings

Coupling (S x S)



Size (inch)	Electrofusion Code	Fast-Lock Code	N (inch)
1 ½	527001	375 170 001	0.06
2	527002	375 170 002	0.06
3	527003	375 170 003	0.13
4	527004	375 170 004	0.13
6	527006		0.19

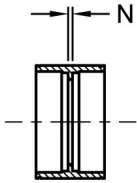

Sleeve Coupling (S x S) (Copy)

4" & 6" Sleeve Couplings Require Metal Clamps



Size (inch)	Code	L (inch)
1 ½	527041	1.56
2	527042	1.81
3	527043	2.00
4	527044	2.00
6	527046	2.69

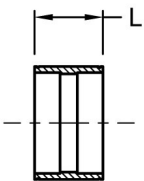

1/4 Bend (91.2°) - Short Sweep (S x S)

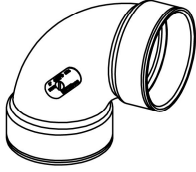

Size (inch)	Electrofusion Code	Fast-Lock Code	G (inch)
1 1/2	526251	375 182 501	1.75
2	526252	375 182 502	2.31
3	526253	375 182 503	3.06
4	526254	375 182 504	3.88
6	526256		5.63

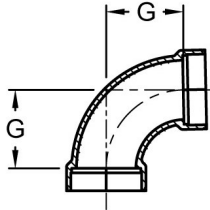

1/4 Bend (91.2°) - Long Sweep (S x S)

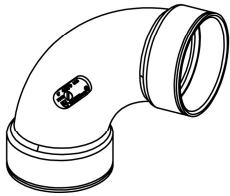

Size (inch)	Electrofusion Code	Fast-Lock Code	G (inch)
1 1/2	526276	375 162 701	2.75
2	526277	375 162 702	3.25
3	526278	375 162 703	4.06
4	526279	375 162 704	4.94
6	526280F		11.00

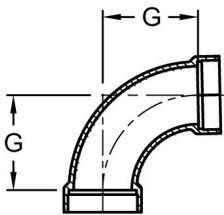

1/4 Bend (91.2°) - Street (S x SPG)

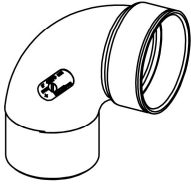

Size (inch)	Electrofusion Code	Fast-Lock Code	G (inch)	K (inch)
1 1/2	526451	375 164 501	1.75	3.11
2	526452	375 164 502	2.31	3.70
3	526453	375 164 503	3.06	4.75
4	526454	375 164 504	3.88	5.38
6	526456F		11.00	10.81

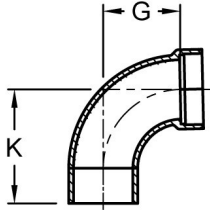

1/4 Bend (90°) - Vent (S x S)

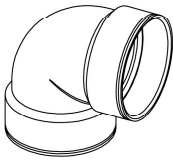

Size (inch)	Electrofusion Code	Fast-Lock Code	G (inch)
1 1/2	526201	375 162 001	1.19
2	526202	375 162 002	1.50
3	526203	375 162 003	1.88

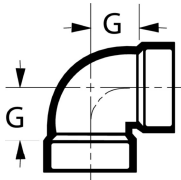

1/6 Bend (60°) - (S x S)

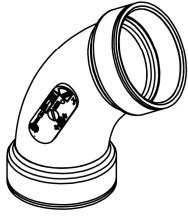

Size (inch)	Electrofusion Code	Fast-Lock Code	J (inch)
1 1/2	526601	375 166 001	1.00
2	526602	375 166 002	1.31
3	526603	375 166 003	1.69
4	526604	375 166 004	2.06

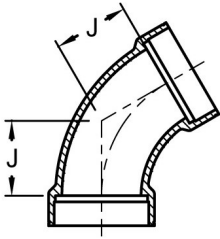

1/8 Bend (45°) - (S x S)



Size (inch)	Electrofusion Code	Fast-Lock Code	J (inch)
1 1/2	526501	375 165 001	1.13
2	526502	375 165 002	1.50
3	526503	375 165 003	1.75
4	526504	375 165 004	2.19
6	526506		3.37

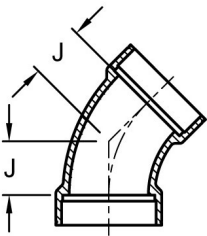

1/8 Bend (45°) - Street (S x SPG)

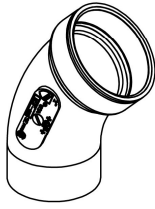

Size (inch)	Electrofusion Code	Fast-Lock Code	J (inch)	K (inch)
1 1/2	526401	375 164 001	1.13	2.44
2	526402	375 164 002	1.50	2.50
3	526403	375 164 003	1.75	3.25
4	526404	375 164 004	2.19	3.25
6	526406		3.38	4.75

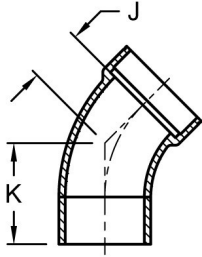

1/12 Bend (30°) - (S x S)



Size (inch)	Electrofusion Code	Fast-Lock Code	J (inch)
1 1/2	526951	375 169 501	0.75
2	526952	375 169 502	0.88
3	526953	375 169 503	1.25
4	526954	375 169 504	1.50

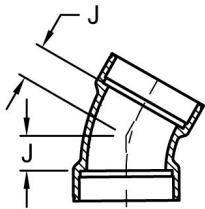

1/12 Bend (30°) - Street (S x SPG)



Size (inch)	Electrofusion Code	Fast-Lock Code	J (inch)	K (inch)
1 1/2	526461	375 164 601	0.75	1.88
2	526462	375 164 602	0.88	2.26
3	526463	375 164 603	1.25	2.56
4	526464	375 164 604	1.50	2.81

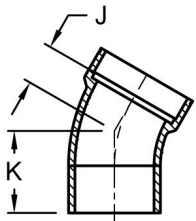

1/16 Bend (22.5°) - (S x S)



Size (inch)	Electrofusion Code	Fast-Lock Code	J (inch)
1 1/2	526551	375 165 501	0.50
2	526552	375 165 502	0.69
3	526553	375 165 503	0.81
4	526554	375 165 504	1.00
6	526556F		6.25

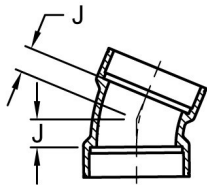

1/24 Bend (15°) - (S x S)



Size (inch)	Electrofusion Code	Fast-Lock Code	J (inch)
1 1/2	526971	375 169 701	0.62
2	526972	375 169 702	0.63
3	526973	375 169 703	0.81
4	526974	375 169 704	0.87

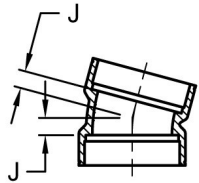

1/24 Bend (15°) - Street (S x SPG)



Size (inch)	Electrofusion Code	Fast-Lock Code	J (inch)	K (inch)
1 1/2	526961	375 169 601	0.62	1.51
2	526962	375 169 602	0.63	1.75
3	526963	375 169 603	0.81	2.12
4	526964	375 169 604	0.88	2.18

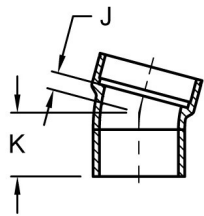

3-Way Ell (91.2) (S x S x S)

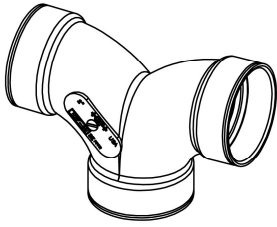

Size (inch)	Electrofusion Code	Fast-Lock Code	G (inch)
1 1/2	526261	375 162 601	1.75
2	526262	375 162 602	2.31

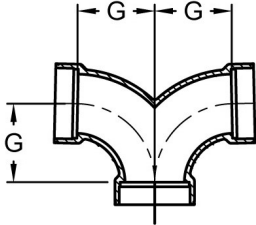

45° Wye (S x S x S)

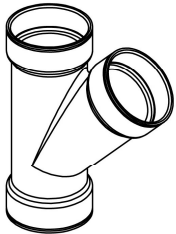

Size (inch)	Electrofusion Code	Fast-Lock Code	GJ (inch)	GN (inch)	N (inch)
1 1/2	526301	375 163 001	2.88	1.13	4.00
2	526302	375 163 002	3.63	1.38	5.00
3	526303	375 163 003	5.00	1.63	6.63
4	526304	375 163 004	6.38	1.88	8.25
6	526306		9.13	1.63	10.75

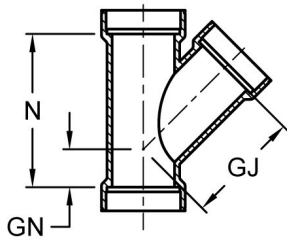

45° Wye - Reducing (S x S x S)

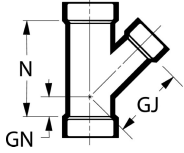
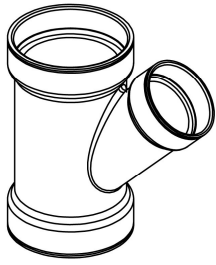

Size (inch)	Electrofusion Code	Fast-Lock Code	GJ (inch)	GN (inch)	N (inch)
2 x 2 x 1 1/2	526325	375 163 030	3.44	1.06	4.38
3 x 3 x 1 1/2	526324	375 163 031	6.25	0.88	5.00
3 x 3 x 2	526326	375 163 032	4.63	0.88	5.00
4 x 4 x 2	526328	375 163 034	5.56	0.38	5.06
4 x 4 x 3	526327	375 163 035	6.00	1.06	6.63
6 x 6 x 2	526342		6.75	-1.13	4.73
6 x 6 x 3	526343		7.43	0.19	6.38
6 x 6 x 4	526344		7.75	0.68	7.73

45° Wye - Double (S x S x S x S)

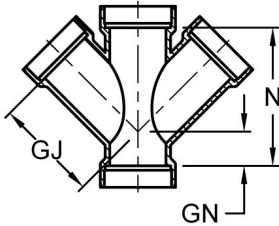
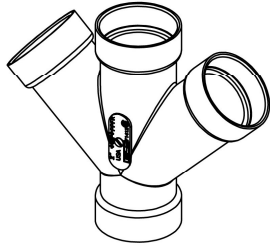

Size (inch)	Electrofusion Code	Fast-Lock Code	GJ (inch)	GN (inch)	N (inch)
1 1/2	526380	375 163 501	3.50	1.13	4.63
2	526381	375 163 502	4.00	1.38	5.38
3	526382	375 163 503	5.00	1.63	7.63
4	526383	375 163 504	6.38	1.88	9.25
6	526351F		12.18	6.18	18.38

45° Wye - Double Reducing (S x S x S x S)

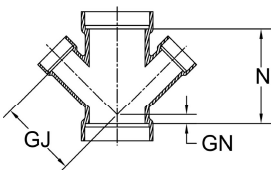
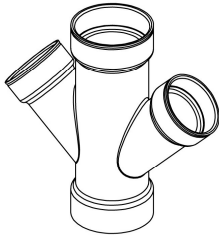

Size (inch)	Electrofusion Code	Fast-Lock Code	GJ (inch)	GN (inch)	N (inch)
2 x 2 x 1 1/2 x 1 1/2	526384	375 163 530	3.44	1.06	5.38
3 x 3 x 1 1/2 x 1 1/2	526389	375 163 531	4.31	0.50	5.25
3 x 3 x 2 x 2	526385	375 163 532	4.63	0.88	6.00
4 x 4 x 2 x 2	526386	375 163 534	5.56	0.38	6.06
4 x 4 x 3 x 3	526387	375 163 535	6.00	1.06	7.63
6 x 6 x 3 x 3	526390T		9.94	1.75	12.38
6 x 6 x 4 x 4	526388T		10.13	2.25	12.38

Long Turn Tee Wye (91.2°) (S x S x S)

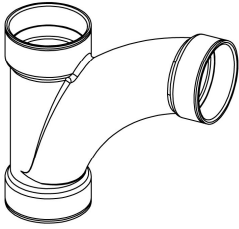

Size (inch)	Electrofusion Code	Fast-Lock Code	G (inch)	N (inch)
1 1/2	527301	375 173 001	3.94	3.63
2	527302	375 173 002	5.13	4.44
3	527303	375 173 003	7.56	6.50
4	527304	375 173 004	9.82	8.75

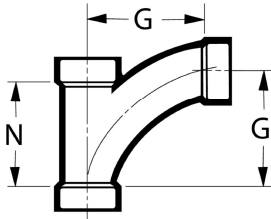

Long Turn Tee Wye (91.2°) - Reducing (S x S x S)

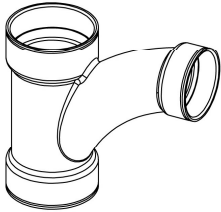

Size (inch)	Electrofusion Code	Fast-Lock Code	GJ (inch)	GK (inch)	N (inch)
2 x 2 x 1 1/2	527320	375 173 030	3.94	4.19	3.63
3 x 3 x 1 1/2	527326	375 173 031	3.94	4.75	3.81
3 x 3 x 2	527327	375 173 032	5.13	5.69	4.75
4 x 4 x 2	527337	375 173 034	5.13	6.13	4.50
4 x 4 x 3	527338	375 173 035	7.56	8.06	6.50

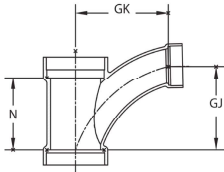

Combo Wye & 1/8 Bend (90°) (S x S x S)



Size (inch)	Electrofusion Code	GJ (inch)	GK (inch)	N (inch)
6	527306F	11.41	13.18	10.75

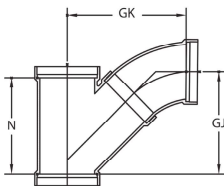

Combo Wye & 1/8 Bend (90°) - Reducing (S x S x S)

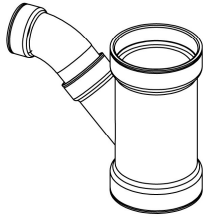

Size (inch)	Electrofusion Code	GJ (inch)	GK (inch)	N (inch)
6 x 6 x 2	527344F	5.44	8.06	4.73
6 x 6 x 3	527339F	7.00	9.19	6.38
6 x 6 x 4	527340F	8.44	9.94	7.73

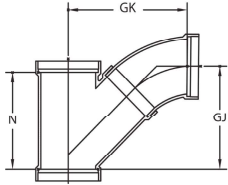

Combo Wye (90°) - Double (S x S x S x S)

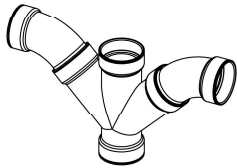

Size (inch)	Electrofusion Code	Fast-Lock Code	GJ (inch)	GK (inch)	N (inch)
1 1/2	526801	375 168 201	5.31	5.31	4.63
2	526802	375 168 202	5.98	6.10	5.38
3	526803	375 168 203	7.47	7.59	7.63
4	526804	375 168 204	8.69	9.00	9.25
6	526806F		18.18	15.44	18.38

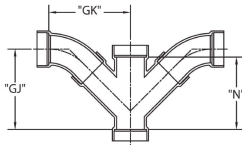

Combo Wye (90°) - Double Reducing (S x S x S x S)



Size (inch)	Electrofusion Code	Fast-Lock Code	GJ (inch)	GK (inch)	N (inch)
2 x 2 x 1 1/2 x 1 1/2	526825	375 168 230	5.22	5.27	5.38
3 x 3 x 1 1/2 x 1 1/2	526824	375 168 231	5.27	5.89	5.25
3 x 3 x 2 x 2	526826	375 168 232	5.91	6.54	6.00
4 x 4 x 2 x 2	526828	375 168 234	6.08	7.20	6.06
4 x 4 x 3 x 3	526827	375 168 235	7.61	8.29	7.63
6 x 6 x 3 x 3	526843T		11.18	11.18	12.38
6 x 6 x 4 x 4	526844T		11.81	11.75	12.38

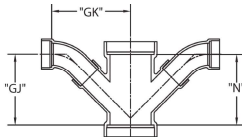

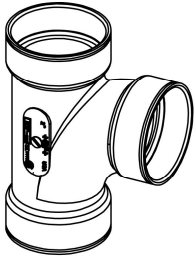

Sanitary Tee (91.2°) (S x S x S)

Size (inch)	Electrofusion Code	Fast-Lock Code	G (inch)	N (inch)
1 1/2	526151	375 161 501	1.75	2.75
2	526152	375 161 502	2.31	3.69
3	526153	375 161 503	3.06	4.88
4	526154	375 161 504	3.88	6.13
6	526156F		14.25	18.38

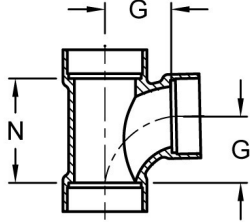

Sanitary Tee (91.2°) - Reducing (S x S x S)

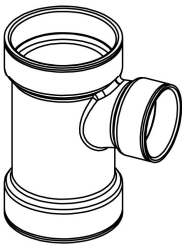

Size (inch)	Electrofusion Code	Fast-Lock Code	GJ (inch)	GK (inch)	N (inch)
2 x 2 x 1 1/2	526126	375 161 530	1.96	2.21	3.17
3 x 3 x 1 1/2	526131	375 161 531	1.75	2.56	2.68
3 x 3 x 2	526130	375 161 532	2.13	2.88	3.31
4 x 4 x 2	526134	375 161 534	2.06	3.31	3.19
4 x 4 x 3	526136	375 161 535	3.00	3.56	4.75
6 x 6 x 2	526137F		3.93	6.00	6.13
6 x 6 x 3	526138F		3.93	6.40	6.13
6 x 6 x 4	526139		3.93	4.90	6.13

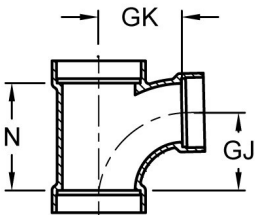

Sanitary Tee (91.2°) - Double (S x S x S x S)

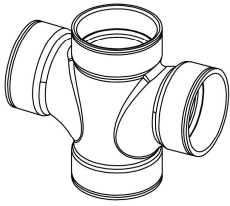

Size (inch)	Electrofusion Code	Fast-Lock Code	G (inch)	N (inch)
1 1/2	526187	375 161 901	1.75	2.75
2	526186	375 161 902	2.31	3.69
3	526183	375 161 903	3.06	4.88
4	526185	375 161 904	3.88	6.13

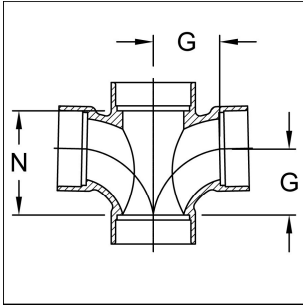

Sanitary Tee (91.2°) - Double Reducing (S x S x S x S)

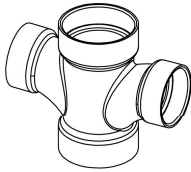

Size (inch)	Code	Code	GJ (inch)	GK (inch)	N (inch)
2 x 2 x 1 1/2 x 1 1/2	526188	375 161 930	1.94	2.19	3.13
3 x 3 x 1 1/2 x 1 1/2	526184F	375 161 931	2.13	4.38	3.31
3 x 3 x 2 x 2	526181	375 161 932	2.13	2.88	3.31
4 x 4 x 2 x 2	526190F	375 161 934	3.88	5.01	6.13
4 x 4 x 3 x 3	526191F	375 161 935	3.88	5.38	6.13

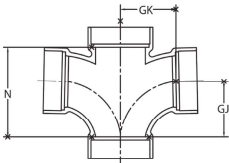

Pipe Increaser (S x S)

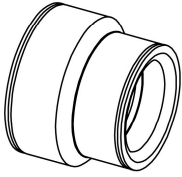

Size (inch)	Electrofusion Code	Fast-Lock Code	N (inch)
1 1/2 x 2	527022	375 170 230	0.53
1 1/2 x 3	527023F	375 170 231	2.63
2 x 3	527024	375 170 232	0.88
2 x 4	527025	375 170 234	1.38
3 x 4	527026	375 170 235	0.94
3 x 6	527027F		1.81
4 x 6	527028F		1.63

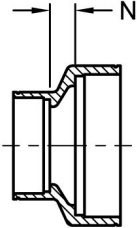

Reducer Bushing (SPG x S)

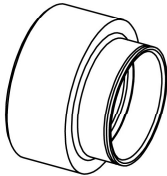

Size (inch)	Electrofusion Code	Fast-Lock Code	N (inch)	X (inch)
2 x 1 1/2	526752	375 187 530	1.61	2.38
3 x 1 1/2	526762	375 187 531	1.50	3.50
3 x 2	526754	375 187 532	1.50	3.50
4 x 2	526758	375 187 534	1.13	4.50
4 x 3	526756	375 187 535	1.50	4.50
6 x 4	526767		1.28	6.63

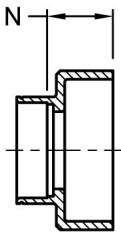

Cap (S)

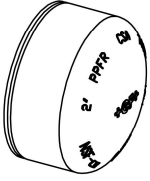

Size (inch)	Electrofusion Code	Fast-Lock Code	HL (inch)
1 ½	527081	375 170 801	0.32
2	527082	375 170 802	0.53
3	527083	375 170 803	0.91
4	527084	375 170 804	1.09
6	527087		1.56

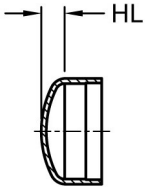

Male Adapter (S x MPT)

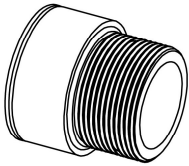

Size (inch)	Electrofusion Code	Fast-Lock Code	HL (inch)
1 ½	526871	375 168 701	1.18
2	526872	375 168 702	1.25
3	526873	375 168 703	1.84
4	526874	375 168 704	2.00
6	526876F		3.50

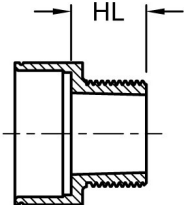

Female Adapter (S x FPT)

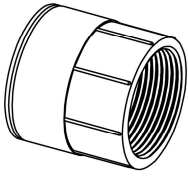

Size (inch)	Electrofusion Code	Fast-Lock Code	HL (inch)
1 ½	526891	375 168 901	1.12
2	526892	375 168 902	1.15
3	526893	375 168 903	1.72
4	526894	375 168 904	1.81
6	526896		2.82

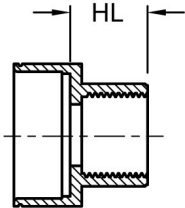

Glass Pipe Adapter (SPG x Glass Pipe Bead)

Compression Coupling and Clamp available from Glass Vendor

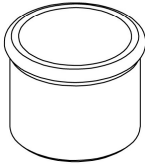

Size (inch)	Code	M (inch)	N (inch)	X (inch)
1 ½	527411	2.06	2.00	1.90
2	527412	2.58	2.00	2.38
3	527413	3.69	2.50	3.50
4	527414	4.84	2.50	4.50
6	527416	7.12	3.00	6.63

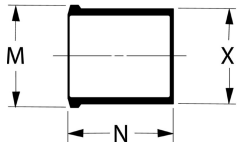

Silicon Iron Pipe Adapter (S x Iron Pipe Bead)

Silicon Iron Clamp available from Iron Pipe Vendor



Size (inch)	Electrofusion Code	Fast-Lock Code	M (inch)	N (inch)
1 ½	527431	375 174 301	2.25	1.88
2	527432	375 174 302	2.72	2.00
3	527433	375 174 303	3.81	2.63
4	527434	375 174 304	4.81	2.63

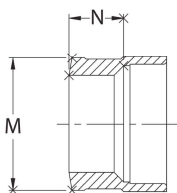

Caulked Joint Adapter (S x Caulked Joint Bead)

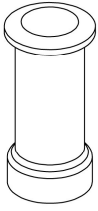

Use with Caulked Joint Coupling

Size (inch)	Code	M (inch)	N (inch)
1 1/2	527441	2.38	4.50
2	527442	2.88	4.25
3	527443	3.88	4.65
4	527444	4.88	4.83

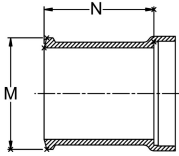

Lead Pipe Adapter (S x Flare)

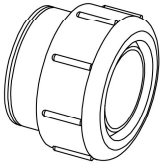

Size (inch)	Electrofusion Code	Fast-Lock Code	HL (inch)
1 1/2	527401	375 174 001	1.12

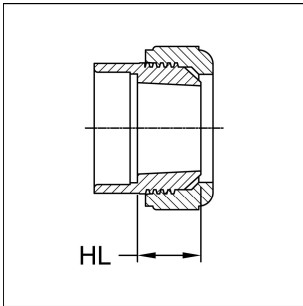

**Polyethylene Adapter
(HDPE Socket x Female Union Nut)**

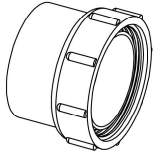

Use with Male Union Adapter

Size (inch)	Electrofusion Code	HL (inch)
1 ½	527268A	0.63
2	527278A	0.75

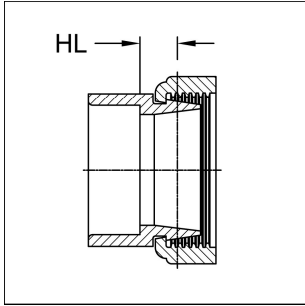

Female Union Nut Adapter (S x Female Union Nut)



Size (inch)	Electrofusion Code	Fast-Lock Code	HL (inch)
1 ½	527260A	375 169 001	0.63
2	527270A	375 169 002	0.75

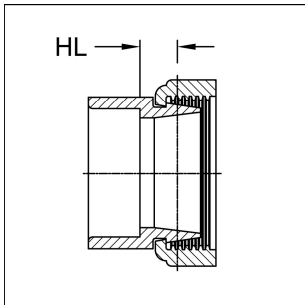

Female Union Nut Adapter (SPG x Female Union Nut)



Size (inch)	Code	HL (inch)
1 1/2	527262A	0.63

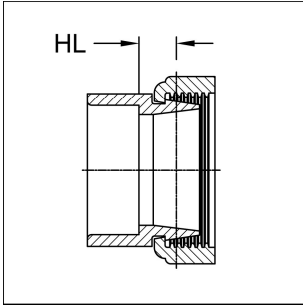

Male Union Adapter (S x Male Union)



Size (inch)	Electrofusion Code	Fast-Lock Code	HL (inch)
1 1/2	527264	375 168 301	0.44

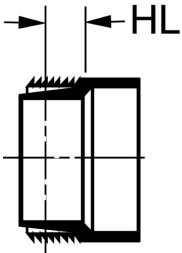

Male Union Adapter (SPG x Male Union)



Size (inch)	Code	HL (inch)
2	527276	0.56

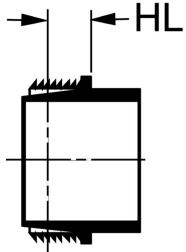

Male Union Adapter (MPT x Male Union)



Size (inch)	Code	HL (inch)
2	527277	0.56

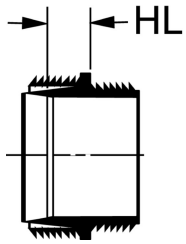

Male Union Adapter (FPT x Male Union)

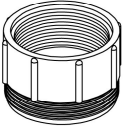

Size (inch)	Code	HL (inch)
2	527275	0.50

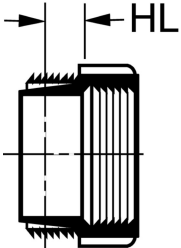

Flange - Van Stone ANSI 150 lb. Pattern (S)

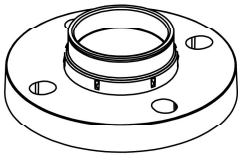

Size (inch)	Electrofusion Code	Fast-Lock Code	# holes	bolt hole dia. (inch)	bolt cir. dia. (inch)	D (inch)	N (inch)	W (inch)
1 ½	526931	375 169 301	4	0.56	3.88	5.00	0.31	0.75
2	526932	375 169 302	4	0.68	4.75	6.00	0.34	0.81
3	526933	375 169 303	4	0.75	6.00	7.50	0.44	1.00
4	526934	375 169 304	8	0.75	7.50	9.00	0.42	1.10
6	526936		8	0.88	9.50	11.00	0.45	1.26

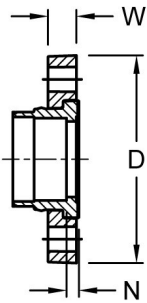

Union (PPFR x PPFR)/PPFR Nut (S x S)

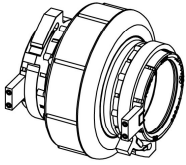

Size (inch)	FKM Electrofusion Code	EPDM Electrofusion Code	D (inch)	L (inch)	N (inch)
1 ½	528291	527271	3.75	3.38	0.63
2	528292	527272	4.63	3.75	0.75
3	528293	527273	6.75	4.68	0.90
4	528294	527274	8.50	5.54	1.00

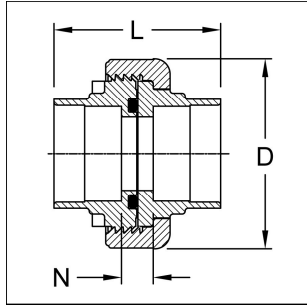

Expansion Joint EPDM (S x SPG)

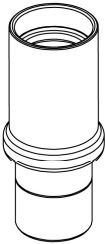

Size (inch)	EPDM Electrofusion Code	EPDM Fast- Lock Code	A (inch)	B (inch)	C (inch)	D (inch)	L (inch)
1 ½	527811A	375 178 101	0.97	4.09	0.75	2.65	4.10
2	527812A	375 178 102	1.19	4.53	0.88	3.15	4.50
3	527813A	375 178 103	1.59	5.31	0.94	4.64	5.25
4	527814A	375 178 104	2.09	6.34	0.94	5.78	5.69

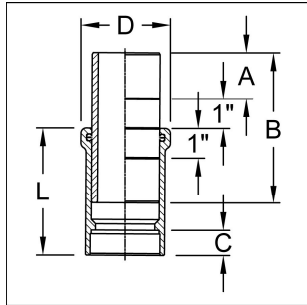

Expansion Joint FKM (S x SPG)

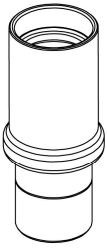

Size (inch)	FKM Electrofusion Code	FKM Fast- Lock Code	A (inch)	B (inch)	C (inch)	D (inch)	L (inch)
1 ½	37A178001	375 178 001	0.97	4.09	0.75	2.65	4.10
2	37A178002	375 178 002	1.19	4.53	0.88	3.15	4.50
3	37A178003	375 178 003	1.59	5.31	0.94	4.64	5.25
4	37A178004	375 178 004	2.09	6.34	0.94	5.78	5.69

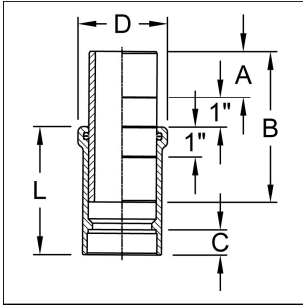

Metal Transition Fitting (PPFR x SS)(SPG x SPG)

Instruments:

- USPH Compliant Transition

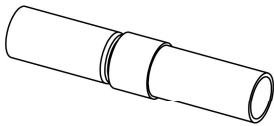

Size (inch)	Code	L (inch)	L1 (inch)	L2 (inch)	X (inch)	X1 (inch)
2 x 2	528729	21.96	10.50	10.00	2.38	2.38
3 x 2 1/2	528730	22.13	9.50	10.13	3.50	2.88
3 x 3	528731	22.13	9.50	10.13	3.50	3.50
4 x 4	528732	22.63	9.50	11.50	4.50	4.50

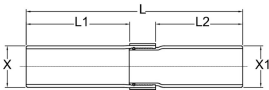

Metal Transition Fitting (PPFR x SS)(SPG x MPT)

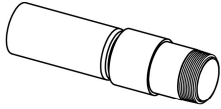

Size (inch)	Code	L (inch)	L1 (inch)	L2 (inch)	X (inch)
2 x 2	528907	11.72	6.50	3.72	2.38

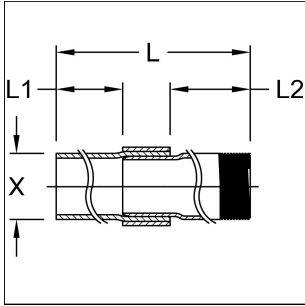

Fuseal Cleanouts & Floor Drains PPFR

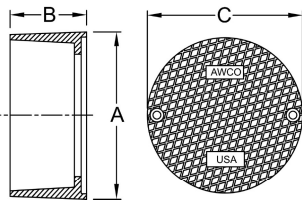

Nickel Bronze Floor Cleanout Housing

Size (inch)	Code	A (inch)	B (inch)	C (inch)
All	527715A	6.13	2.81	5.70

Nickel Bronze Floor Cleanout Assembly (S)

2" adjustment

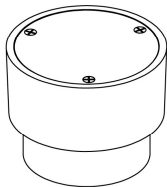

Size (inch)	Electrofusion Code	Fast-Lock Code	A (inch)	B (inch)	C (inch)	N (inch)
3	527713A	375 177 103	6.13	2.81	5.70	2.78
4	527714A	375 177 104	6.13	2.81	5.70	3.06

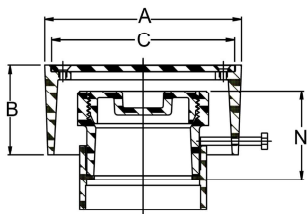

Cleanout Tee with Plug (S x S x FT)

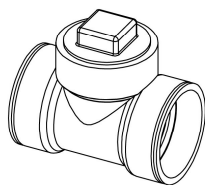

Size (inch)	Electrofusion Code	Fast-Lock Code	HL (inch)	N (inch)
1 ½	526114A	375 161 101	1.82	2.12
2	526115A	375 161 102	2.13	2.74
3	526116A	375 161 103	2.63	3.75
4	526117A	375 161 104	3.38	5.00
6	526118AF		7.75	18.00

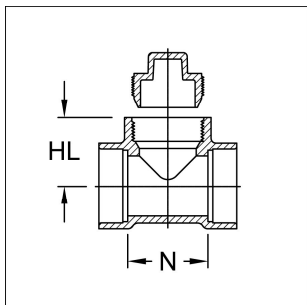

Cleanout Adapter with Plug (SPG x FT)

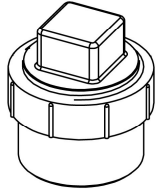

Size (inch)	Code	HL (inch)	N (inch)	X (inch)
1 1/2	527701A	0.78	2.09	1.90
2	527702A	0.78	2.22	2.38
3	527703A	1.09	2.66	3.50
4	527704A	1.13	2.94	4.50
6	527706A	1.31	2.63	6.63

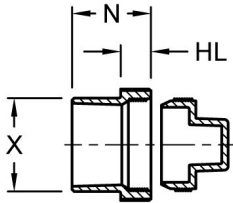

Countersunk Plug for Cleanout (MT)

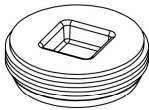

Size (inch)	Code	L (inch)	Q (inch)
3	527063	1.03	1.31
4	527064	1.16	1.63

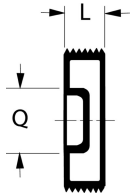

Plug (MT)

Use with cleanout tees, cleanout adapters and cleanout p-traps only

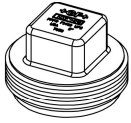

Size (inch)	Code	L (inch)	Q (inch)	Remarks
1	527049	0.99	0.75	Used for 527201A & 527202A
1 ½	527051	1.56	1.00	Used for 527203A & 527204A
2	527052	1.54	1.25	
3	527053	2.03	1.63	
4	527054	2.16	2.00	
6	527057	2.38	2.38	

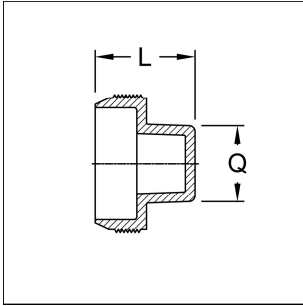

Floor Drain (S)

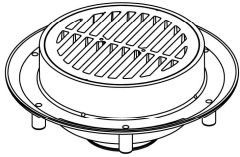

Size (inch)	Electrofusion Code	Fast-Lock Code	A (inch)	B (inch)	C (inch)	D (inch)	E (inch)	F (inch)
2	527749F	375 177 402	8.50	12.00	1.63	6.69	5.06	5.81
3	527750	375 177 403	8.50	12.00	1.63	5.25	3.63	4.31
4	527751	375 177 404	8.50	12.00	1.63	5.25	3.63	4.31
6	527752F		8.50	12.00	1.63	7.26	5.63	6.00

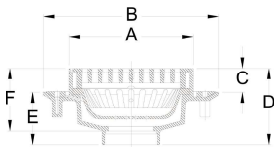

Replacement Strainer for Floor Drain

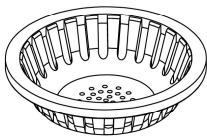

Size (inch)	Code
All	527502A

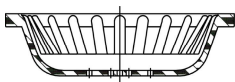

Replacement Grate for Floor Drain

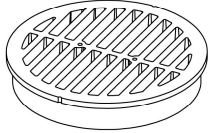

Size (inch)	Code
All	527503A



Anti-Splash Funnel for Floor Drain

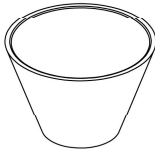

Size (inch)	Code	G (inch)	H (inch)
All	527505A	6.00	4.00

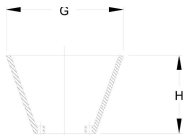

Stainless Steel Adjustable Floor Drains

Drains have a pipe spigot end and come standard with a sediment bucket. Drain design has a section to tap for trap primer. Optional square and round grates are available.

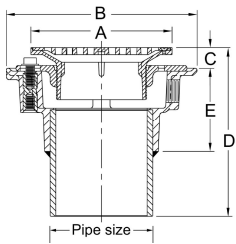

Size (inch)	Code	Description	A (inch)	B (inch)	D (inch)	E (inch)
2	150 999 100	6" Round SS drain C= 3/4 to 2 1/2"	6.00	8.38	5.00	3.00
3	150 999 101	6" Round SS drain C= 3/4 to 2 1/2"	6.00	8.38	6.19	3.69
4	150 999 102	6" Round SS drain C= 3/4 to 2 1/2"	6.00	8.38	6.31	3.81

Fuseal Traps PPFR

P-Trap (SxS)

1-1/2" - 4" U-Bend Joint must be fused in the field
 6" U-Bend Joint is Factory Fused

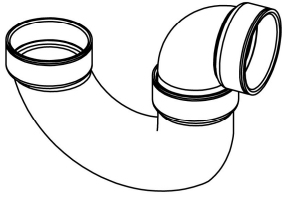

Size (inch)	Electrofusion Code	Fast-Lock Code	GJ (inch)	GN (inch)	L1 (inch)	L2 (inch)	L3 (inch)
1 1/2	527201	375 172 001	4.71	1.68	2.06	3.64	3.50
2	527202	375 172 002	6.94	2.44	2.71	4.75	5.06
3	527203	375 172 003	8.88	2.79	3.41	6.43	6.75
4	527204	375 172 004	10.75	3.88	3.88	8.06	8.50
6	527206F		20.88	5.63	9.19	15.25	15.25

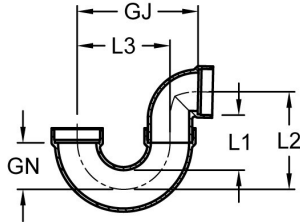

P-Trap with Cleanout (S x S)

1-1/2" - 4" U-Bend Joint must be fused in the field

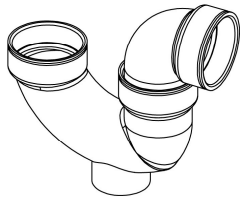

Size (inch)	Electrofusion Code	Fast-Lock Code	GJ (inch)	GN (inch)	L1 (inch)	L2 (inch)	L3 (inch)
1 1/2	527201A	375 171 901	4.71	1.68	2.06	3.64	3.50
2	527202A	375 171 902	6.94	2.44	2.71	4.75	5.06
3	527203A	375 171 903	8.88	2.79	3.41	6.43	6.75
4	527204A	375 171 904	10.75	3.88	3.88	8.06	8.50

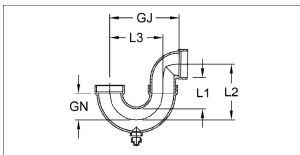

P-Trap with Union Connection (S x S)

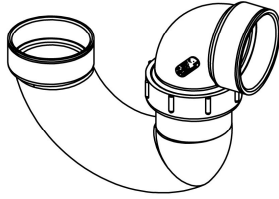

Size (inch)	Electrofusion Code	Fast-Lock Code	GJ (inch)	GN (inch)	L1 (inch)	L2 (inch)	L3 (inch)
1 1/2	527211E	375 172 101	4.84	1.68	2.38	4.00	3.50
2	527212E	375 172 102	6.50	2.44	2.84	4.88	5.06

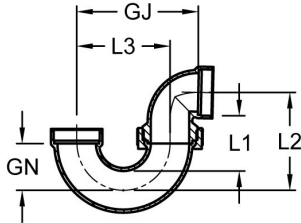

**P-Trap with Union Connection
(Slip Joint Inlet x S)
(Slip Joint Inlet x FPT)**

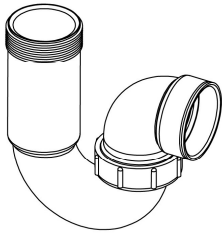

Size (inch)	Electrofusion Code	Fast-Lock Code	(FPT) Code	GJ (inch)	GN (inch)	L1 (inch)	L2 (inch)	L3 (inch)
1 1/2	527225	375 172 201	527235	4.51	1.80	2.08	3.71	3.30

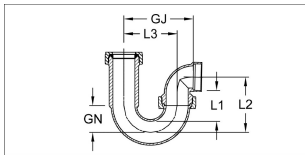

Jar Trap (FPT Inlet x S Outlet)

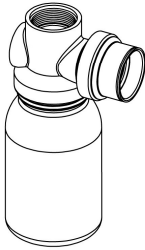

Size (inch)	Electrofusion Code	Fast-Lock Code	L (inch)	L1 (inch)	N (inch)
1 1/2	527242C	375 172 401	9.50	1.63	2.75

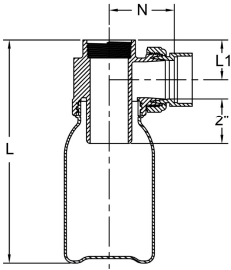

Replacement Polypropylene Jar for Jar Trap Translucent



Size (inch)	NFR Code
1 Quart	37X005006

Replacement Gasket for Jar Trap



Size (inch)	Code
1 Quart	37X002101

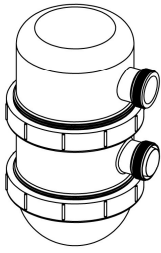

**Drum Trap with Domed Cap
(Male Union Thread x Male Union Thread)**

Use with Union Nut Adapters: 527260A, 527270A or 527262A

Size (inch)	Code	D (inch)	G (inch)	L (inch)	L1 (inch)	L2 (inch)
1 ½	527246A	6.50	4.31	13.44	2.75	4.50
2	527247A	6.50	4.31	13.44	2.75	4.50

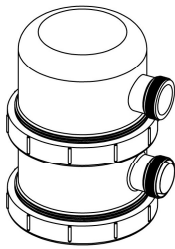
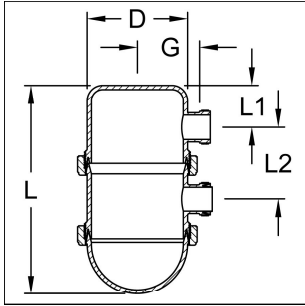

**Drum Trap with Flat Cap
(Male Union Thread x Male Union Thread)**

Use with Union Nut Adapters: 527260A or 527262A

Size (inch)	Code	D (inch)	G (inch)	L (inch)	L1 (inch)	L2 (inch)
1 ½	527246B	6.50	4.31	10.50	2.75	4.50

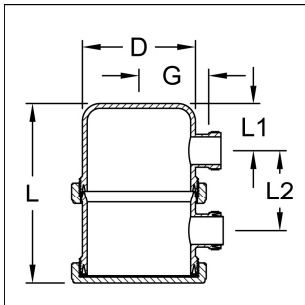

Drum Trap (S x S)

Must field fuse body

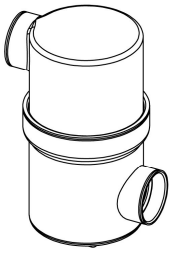

Size (inch)	Electrofusion Code	Fast-Lock Code	D (inch)	G (inch)	L (inch)	L1 (inch)	L2 (inch)
1 1/2	527248	375 166 201	4.50	2.25	9.34	1.25	5.13
2	527249	375 166 202	4.50	2.38	9.34	1.35	5.13

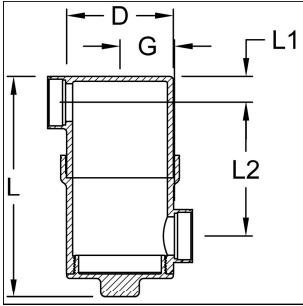

P-Trap Inlet/Outlet Pipe (SPG x MPT)

Size (inch)	Code	L (inch)	X (inch)
1 1/2	527538	18.00	1.90

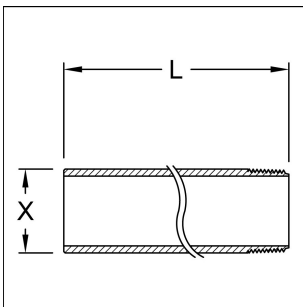

Sink Strainer Assembly (MT)

Includes Sink Strainer, Gasket, Plug and Locknut

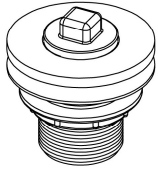

Size (inch)	Code	L (inch)	M (inch)	R (inch)
1 ½	527841A	2.75	3.31	0.25

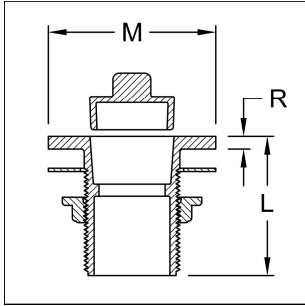

Sink Strainer Adapter (FT x SPG)

Size (inch)	Code	D (inch)	L (inch)	X (inch)
1 ½	527451	2.88	3.38	1.90

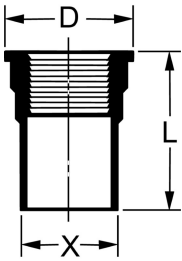

Swivel Sink Strainer Adapter with Gasket (S x FT)

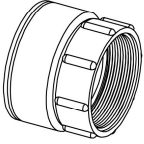

Size (inch)	Electrofusion Code	Fast-Lock Code	L (inch)	N (inch)
1 1/2	527217	375 176 601	1.72	0.44

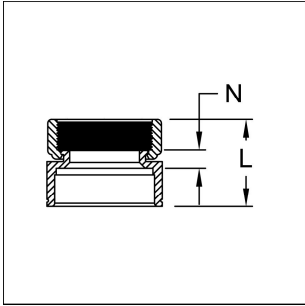

Swivel Sink Strainer Adapter with Gasket (SPG x FT)

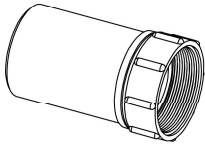

Size (inch)	Code	L (inch)
1 1/2	527216	2.50
1 1/2	527218	13.00

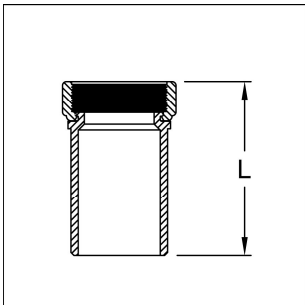

Swivel Sink Strainer Adapter with Gasket (SPG x FT) and Dishwasher Hook-up

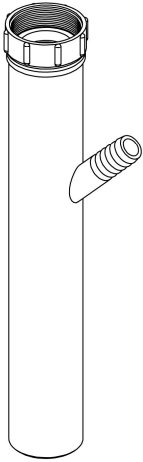

Size (inch)	Code	D (inch)	L (inch)	L2 (inch)
1 1/2	150 991 103	0.79	13.00	5.50

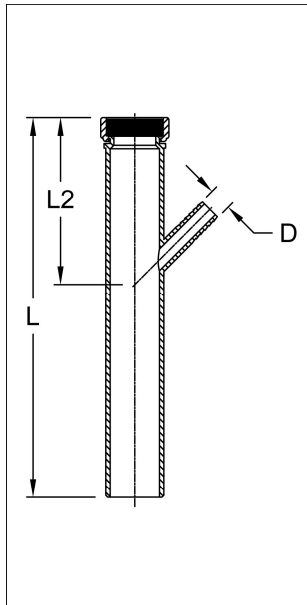

Replacement Gasket for Swivel Sink Strainer Adapter



Material: FKM
 • Material : FKM

Material : FKM

Size (inch)	Code	Pack Qty
1 1/2	37X002100	5

Tailpiece Adapter (SPG x Brass Nut)



Size (inch)	Code	L (inch)	X (inch)
1 1/2	527561	2.13	1.90

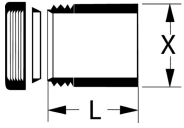

Trap Primer with FPT Tap (SPG x SPG)

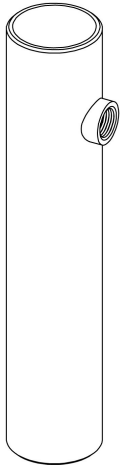

Size (inch)	Code	L (inch)	X (inch)	FPT (inch)
1 1/2	527221F	12.00	1.90	1/2
2	527222F	12.00	2.38	1/2
3	527223F	12.00	3.50	1/2
4	527224F	12.00	4.50	1/2
6	527226F	12.00	6.63	3/4

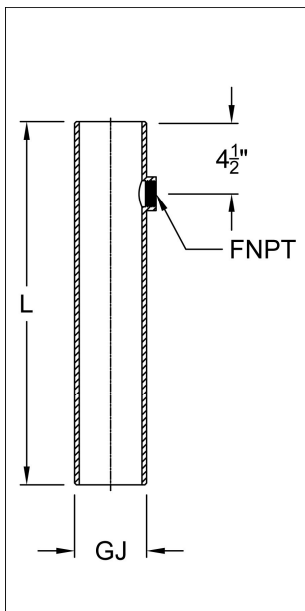

Cup Sink - MT Outlet

Includes Sink Strainer, Plug and Retainer Nut

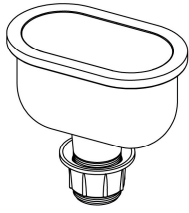

Size (inch)	Code	H (inch)	H1 (inch)	L (inch)	L1 (inch)	W (inch)	W1 (inch)
1 1/2	527851A	7.00	4.00	9.75	8.56	4.50	3.31
1 1/2	527852A	7.00	4.00	7.50	6.31	4.50	3.31

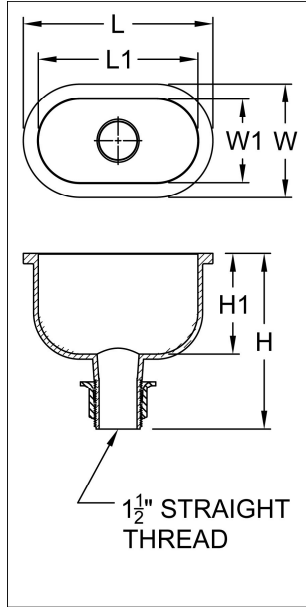

Replacement Parts for Cup Sink



Description	Code
Strainer	527853
Plug	527854

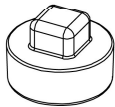

Fuseal LD Fusion Fittings PP

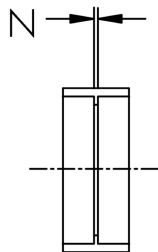

Coupling (S x S)

Size (inch)	FR Code	NFR Code	N (inch)
8	527008		0.25
10	527100		0.25
12	527120		0.25
14		217014	0.25

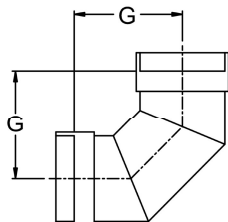

1/4 Bend (90°) - 3 Segment (S x S)

Size (inch)	NFR Code	FR Code	G (inch)
8	216258F	526258F	12.25
10	216255F	526255F	14.25
12	216257F	526257F	16.25

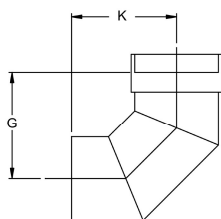

1/4 Bend (90°) - Street (S x SPG)

Size (inch)	NFR Code	FR Code	G (inch)	K (inch)
8	216458F	526458F	12.25	12.00
10	216455F	526455F	14.25	14.00
12	216457F	526457F	16.25	16.00

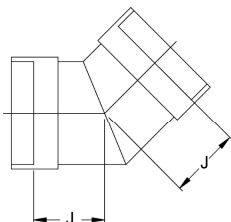

1/8 Bend (45°) (S x S)

Size (inch)	NFR Code	FR Code	J (inch)
8	216508F	526508F	6.94
10	216505F	526505F	7.75
12	216507F	526507F	8.50

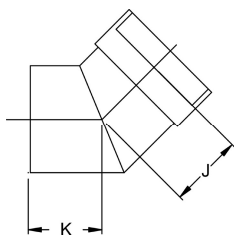

1/8 Bend (45°) - Street (S x SPG)

Size (inch)	NFR Code	FR Code	J (inch)	K (inch)
8	216408F	526408F	6.94	6.69
10	216405F	526405F	7.75	7.25
12	216407F	526407F	8.50	8.25

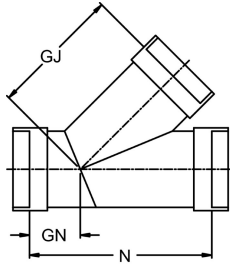

45° Wye (S x S x S)

Size (inch)	NFR Code	FR Code	GJ (inch)	GN (inch)	N (inch)
8	216308F	526308F	15.50	7.00	22.50
10	216305F	526305F	20.75	7.75	28.50
12	216300F	526300F	22.00	8.50	30.50

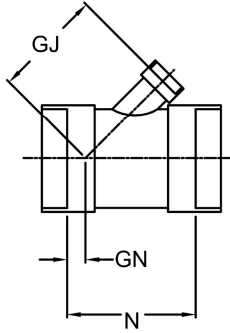

45° Wye - Reducing (S x S x S)

Size (inch)	NFR Code	FR Code	GJ (inch)	GN (inch)	N (inch)
8 x 8 x 3	216347T	526347T	10.50	1.50	12.00
8 x 8 x 4	216346T	526346T	11.00	2.00	13.00
8 x 8 x 6	216345T	526345T	12.50	3.50	16.00
10 x 10 x 3	216321T	526321T	12.00	2.00	14.00
10 x 10 x 4	216322T	526322T	12.63	2.13	14.75
10 x 10 x 6	216323T	526323T	14.50	4.00	18.50
10 x 10 x 8	216324T	526324T	15.75	5.25	21.00
12 x 12 x 4	216332T	526332T	14.00	1.50	15.50
12 x 12 x 6	216333T	526333T	15.50	3.00	18.50
12 x 12 x 8	216334T	526334T	17.25	4.50	24.75
12 x 12 x 10	216335T	526335T	19.25	6.00	25.25

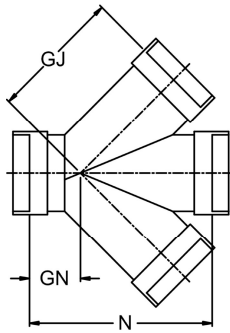

45° Wye - Double (S x S x S x S)

Size (inch)	NFR Code	FR Code	GJ (inch)	GN (inch)	N (inch)
8	216352F	526352F	15.50	7.00	22.50
10	216355F	526355F	20.75	7.75	28.50
12	216350F	526350F	22.00	8.50	30.50

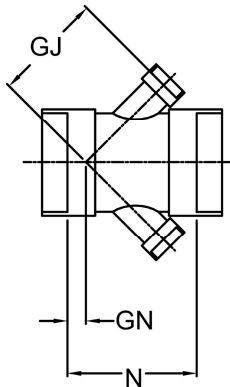

45° Wye - Double Reducing (S x S x S x S)

Size (inch)	NFR Code	FR Code	GJ (inch)	GN (inch)	N (inch)
8 x 8 x 3 x 3	216389T	526393T	10.50	1.50	12.00
8 x 8 x 4 x 4	216388T	526391T	11.00	2.00	13.00
8 x 8 x 6 x 6	216386T	526392T	12.50	3.50	16.00
10 x 10 x 3 x 3	216370T	526370T	13.18	2.18	15.38
10 x 10 x 4 x 4	216371T	526371T	12.63	2.13	14.75
10 x 10 x 6 x 6	216372T	526372T	14.50	4.00	18.50
10 x 10 x 8 x 8	216373T	526373T	15.75	5.25	21.00
12 x 12 x 4 x 4	216382T	526394T	14.00	1.50	15.50
12 x 12 x 6 x 6	216383T	526395T	15.50	3.00	18.50
12 x 12 x 8 x 8	216384T	526396T	17.25	4.50	21.75
12 x 12 x 10 x 10	216385T	526397T	19.25	6.00	25.25

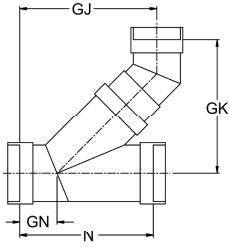

Combo Wye & 1/8 Bend (90°) (S x S x S)

Size (inch)	NFR Code	FR Code	GJ (inch)	GK (inch)	GN (inch)	N (inch)
8	216716F	526716F	22.63	22.63	7.00	22.50
10	216700F	526700F	27.75	27.75	7.75	28.50
12	216701F	526701F	30.00	30.00	8.50	30.50

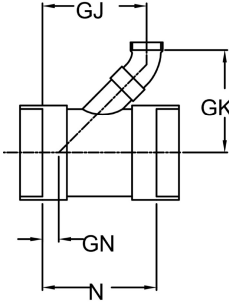

Combo Wye & 1/8 Bend (90°) - Reducing (S x S x S)

Size (inch)	NFR Code	FR Code	GJ (inch)	GK (inch)	GN (inch)	N (inch)
8 x 8 x 3	216709T	526709T	11.25	11.50	1.50	12.00
8 x 8 x 4	216717T	526717T	12.00	12.25	2.00	13.00
8 x 8 x 6	216715T	526715T	15.69	15.56	3.50	16.00
10 x 10 x 3	216707T	526707T	12.81	12.56	2.00	14.00
10 x 10 x 4	216721T	526721T	13.38	13.44	2.13	14.75
10 x 10 x 6	216711T	526711T	17.63	17.00	4.00	18.50
10 x 10 x 8	216712T	526712T	21.13	22.75	5.25	21.00
12 x 12 x 4	216720T	526720T	13.69	14.38	1.50	15.50
12 x 12 x 6	216718T	526718T	17.31	17.69	3.00	18.50
12 x 12 x 8	216719T	526719T	21.44	23.81	4.50	24.75
12 x 12 x 10	216710T	526710T	24.88	26.69	6.00	25.25

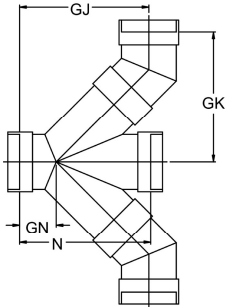

Combo Wye (90°) - Double (S x S x S x S)

Size (inch)	NFR Code	FR Code	GJ (inch)	GK (inch)	GN (inch)	N (inch)
8	216816F	526816F	22.63	22.63	7.00	22.50
10	216800F	526800F	27.75	27.75	7.75	28.50
12	216801F	526801F	30.00	30.00	8.50	30.50

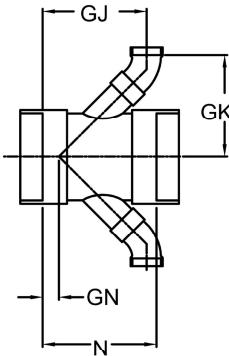

Combo Wye (90°) - Double Reducing (S x S x S x S)

Size (inch)	NFR Code	FR Code	GJ (inch)	GK (inch)	GN (inch)	N (inch)
8 x 8 x 3 x 3	216809T	526809T	11.25	11.50	1.50	12.00
8 x 8 x 4 x 4	216817T	526817T	12.00	12.25	2.00	13.00
8 x 8 x 6 x 6	216815T	526815T	15.69	15.56	3.50	16.00
10 x 10 x 3 x 3	216807T	526807T	12.81	12.56	2.00	14.00
10 x 10 x 4 x 4	216821T	526821T	13.38	13.44	2.13	14.75
10 x 10 x 6 x 6	216811T	526811T	17.63	17.00	4.00	18.50
10 x 10 x 8 x 8	216812T	526812T	21.13	22.75	5.25	21.00
12 x 12 x 4 x 4	216820T	526820T	13.69	14.38	1.50	15.50
12 x 12 x 6 x 6	216818T	526818T	17.31	17.69	3.00	18.50
12 x 12 x 8 x 8	216819T	526819T	21.44	23.81	4.50	21.75
12 x 12 x 10 x 10	216810T	526810T	24.88	26.69	6.00	25.25

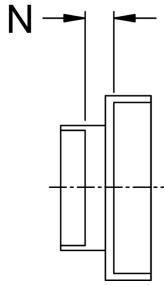

Pipe Increaser (S x S)

Size (inch)	NFR Code	FR Code	N (inch)
8 x 3		527035F	2.00
8 x 4		527034F	1.75
8 x 6		527033F	1.63
10 x 3	217040F	527040F	1.00
10 x 4	217030F	527030F	1.18
10 x 6	217031F	527031F	1.50
10 x 8	217032F	527032F	2.13
12 x 4	217036F	527036F	1.00
12 x 6	217037F	527037F	1.50
12 x 8	217038F	527038F	2.00
12 x 10	217039F	527039F	3.00

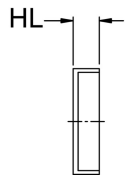

Cap (S)

Size (inch)	NFR Code	FR Code	HL (inch)
8		527088	1.81
10	217090F	527090F	3.38
12	217092F	527092F	3.38

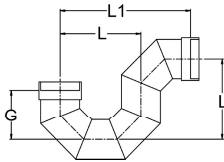

P-Trap (S x S)

Size (inch)	NFR Code	FR Code	G (inch)	L (inch)	L1 (inch)
8	217208F	527208F	12.25	18.25	30.50
10	217210F	527210F	14.25	22.25	36.50
12	217212F	527212F	16.25	26.50	42.75

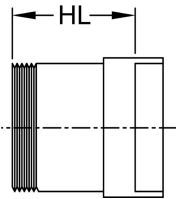

Male Adapter (S x MPT)

Size (inch)	NFR Code	HL (inch)
8	216878F	4.38

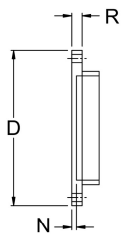

Flange - Van Stone ANSI 150 lb. Pattern (S)

Flange Ring Material: CPVC

Size (inch)	NFR Code	# holes	bolt hole dia. (inch)	bolt cir. dia. (inch)	D (inch)	N (inch)	R (inch)	Bolt Length (inch)
8	216928	8	0.88	11.75	13.50	0.44	1.71	3.50
10	216930	12	1.00	14.25	16.00	0.50	1.73	3.75
12	216932	12	1.00	17.00	19.00	0.50	1.71	4.00

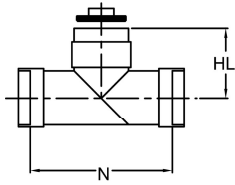

Cleanout Tee with Plug (S x S x FT)

Size (inch)	NFR Code	HL (inch)	N (inch)
8	216119AF	11.00	22.50
10	216120AF	14.00	28.50
12	216121AF	15.00	30.50

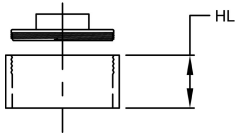

Cleanout Adapter with Plug (SPG x FT)

Size (inch)	NFR Code	HL (inch)
8	217708AF	4.00
10	217710AF	5.00
12	217712AF	5.00

Fuseal Fusion Accessories



Electro Plus®

Advantages

- Intuitive user interface
 - Multiple joint capability for speedy installations
 - Integral carrying case for ease of transportation
 - One-button repeat fusion cycle for same size joints
 - Self-diagnostic error detection system
 - Automatic compensation for ambient temperature
- The Electro Plus® fusion machine can be used to join the following piping systems: Fuseal 1½-12", Fuseal Squared 1½-12", Fuseal 25/50 1½-6" and PPro-Seal ½-3".
- This complete machine includes:
Fusion Power Unit, Hand Held Unit and the Cable Assembly.

Technical Data

Operating Temperature	14°F (-10°C) to 113°F (45°C)
Input Voltage	100-130 V AC / 200-250 V AC
Input Frequency	50Hz - 60 Hz
Output Voltage	0 --28.5 V AC
Output Current	0-50 Amps
Power Consumption	1200 Watts max.
Power Cable Length	5ft. (1.5m)
Fusion Cable Length	18ft. (5.5m)
Remote Cable Length	20ft. (6m)
Dimensions (WxHxD)	22x14x10 inch
Weight	45lbs (20.5kg)

Description	Code	weight (lb)
Electro Plus	150 000 001	45.195



Chamfering tool

- Chamfering tool with 15° bevel for plastic pipes (PVC, ABS, PP, PB, PE). Coated prism surface suitable for clean room applications. Fast and reliable adjustment to different pipe diameters and wall thickness.

d-d (mm)	Code
16 - 200	790 309 003
63 - 400	790 309 004



Chamfering tool

Chamfering tool for PPro-Seal, Fuseal PP, and Fuseal 25/50. Sizes 1 1/4" to 4".

Code	Description
150 109 104	1 1/4" - 4" Chamfering Tool



Fusion Locking Collar with Plastic Clamp

6" Fusion Locking Collars without plastic clamp

Size (inch)	Code	Pack Qty
1 1/2	526042	10
2	526043	10
3	526044	10
4	526045	10
6	526047	10



Plastic Clamp

Size (inch)	Code	weight (lb)	Pack Qty
1 1/2	37A160601	0.022	10
2	37A160602	0.033	10
3	37A160603	0.042	10
4	37A160604	0.110	10

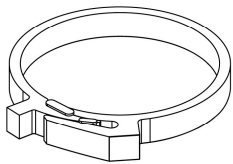

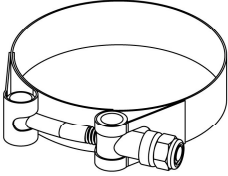
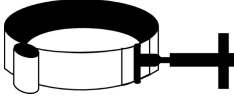

Metal Clamp

Size (inch)	Code	weight (lb)	Pack Qty
6	37Z000600	0.399	1
8	37Z000800	0.500	1
10	37Z001000	0.600	1
12	37Z001200	0.600	1



Channel Locks

Size (inch)	Code	Description	Pack Qty
1 1/2, 2, & 3	37X004817	440 Channel Locks	1
4	37X004818	460 Channel Locks	1



Metal Clamp Torque Tools

- Torque limiting tool for electrofusion metal clamps

Code	Description	Pack Qty
37Z000091	L-Handle Ratchet Torque Tool w/Socket - 65 in-lb	1
37Z000092	T-Handle Torque Tool w/Socket - 65 in-lb	1
37Z000090	Torque Tool Socket - 3/8" Drive	1



60 Grit Sandpaper

Model:

- Sold in roll 2" wide x 50 yards long

Code

37X004819

Fuseal Fast-Lock Accessories

Fuseal Fast-Lock MJ Kit

Includes Fast-Lock MJ Collar, Bolt, & Gasket

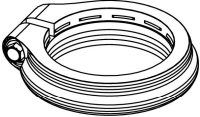

Size (inch)	Code	Pack Qty
1 ½	375 160 001	10
2	375 160 002	10
3	375 160 003	10
4	375 160 004	10



Lock Ring Pliers

Code	Pack Qty
37Z000096	1



Silicon Lubricant

Code	Description	Pack Qty
37Z000097	Dow Molykote 111 Lubricant - 150g Tube	1

General Terms and Conditions of Sale

These GF Piping Systems USA Terms and Conditions (Rev.11/2018) supersede all previous Terms and Conditions for Georg Fischer LLC and Georg Fischer Harvel LLC.

It is the responsibility of the Distributor, Dealer, or Agent to provide a current copy of these Terms and Conditions to the Consumers of Georg Fischer Piping products.

Always check for the most current General Terms and Conditions and Warranty Statement at www.gfpiping.com under "Price Lists," which supersede and replace these General Terms and Conditions and Warranty Statement. If unable to access this website please request a copy at (714) 731-8800.

Acceptance of Terms and Conditions

Acceptance by Customer of GF Piping Systems USA, (hereinafter "Seller") offer of Products for sale is hereby expressly conditioned upon Customer's acceptance of these General Terms and Conditions of Sale and these General Terms and Conditions of Sale will be deemed accepted, as written, despite any language in Customer's purchase order and/or other documentation which is either conflicting or supplemental, unless promptly after this offer, Customer specifically advises Seller of each term and condition not so accepted and Seller accepts Customer's conflicting and/or supplemental term(s) in writing.

Order Acceptance

Seller reserves the right to accept or reject any order. Possession of a price list by Customer does not constitute an offer to sell.

Credit Approval and Minimum Order Charge

Customer credit approval is required prior to any shipment.

The minimum order is \$100 net.

List Price, Discount or Freight Charges

List prices, discount, and freight terms are subject to change without notice. All prices are F.O.B. Seller's factory or authorized warehouse at Seller's discretion.

Quotes

All prices provided by the Seller are in US currency and cover only the goods expressly specified. Quotations are valid for a period of 30 days unless otherwise specified. HDPE Pipe pricing is valid for seven (7) days after quote issuance unless otherwise stated or unless there has been fundamental change to our cost exposure within the seven (7) day period.

Payment Terms

Net 30, from date the invoice is issued unless otherwise stated in a specific quotation. No unauthorized deductions allowed, such as deductions for pending Return Material Transactions that are subject to review. Seller reserves the right to apply a finance charge to the balance of any past-due invoice (over 30 days from date of invoice) at a rate of 1.5% per month, 18% per annum. Payment terms on fusion machine rentals net 30; see rental agreement for more details.

Taxes

Seller charges Customer for all sales, excise and other taxes and governmental charges Seller is required to collect from Customer. Customers claiming exemption must furnish documentation required by law, which is satisfactory to Seller to permit Seller to refrain from collecting such charges.

Order Changes or Cancellations

Cancellation or modifications of orders may be possible only with prior written consent from Seller. Since all orders are individually entered for processing immediately upon receipt, Seller reserves the right to charge back to the Customer costs incurred from either order cancellation or order modification. Seller also reserves the right to consider all order additions as new orders and subject to all terms and conditions. Seller will not cancel orders for custom or non-cancelable products if Seller has already produced the product or incurred expenses toward producing the product at the time the Customer seeks to cancel.

Delivery

Seller disclaims liability for consequential damages from late deliveries unless seller assumes liability for such damages in writing when the order is placed. Further, Seller disclaims liability where delivery delays caused by strike, differences with workmen, or causes beyond Seller's control, including but not limited to fires, floods, accidents, government actions, shortages of labor, raw materials, production facilities, or transportation. Where delivery delays are caused by labor problems, Seller is not obligated to seek or obtain any settlement, which, in Seller's judgment, is not in Seller's best interest.

Standard Packaging

Seller will accept orders from Customer exclusively in multiples of the standard packaging quantity or boxed quantity. Seller reserves the right to reject any order that is not a standard packaging or boxed quantity of a Product.

Freight

Continental US – Full freight will be paid on the following orders:
1. Pipe \$8,000 net or greater in one of the following categories:

Combination of products to meet freight allowance is at the sole discretion of the Seller.
2. Fittings, Valves, & Actuation \$2,200 net or greater

Freight allowed orders will be sent by a designated carrier of Seller's choice. Additional charges will be invoiced to Customer for special handling and airfreight when requested. Standard Pipe lengths require long truck beds for shipping and may be shipped separately from valves and/or fittings purchased on the same order. Valves and/or fittings will be shipped using practical shipping methods.

Freight will not be paid on the following orders:

Unless otherwise specified, shipments are surface, prepaid and added to invoice.

Mode of Shipment and Packaging

Seller reserves the right to ship orders in the most economical manner, as long as the product is shipped on or before the promised ship date. If product ships after the promised ship date, Seller may automatically adjust the shipping method to help improve delivery of the delayed shipment, at no additional cost. If Seller pays freight, Seller may hold shipment until all items become available. Customer bears extra cost of non-standard packaging or handling requested by Customer.

Transfer of Ownership

All products are FOB Seller's facility and title of merchandise transfers when product is loaded onto carrier. Claims for damaged merchandise should be made to carrier by Customer.

Non-Conforming Shipments

Customer must notify Seller in writing within 7 days after receipt of shipments not conforming with Customer's order, stating specifically Customer's claim of non-conformity, or Customer is deemed to accept the shipment as is. If Seller is satisfied the shipment is non-conforming, Seller will (i) credit Customer for the price of defective goods or goods shipped but not ordered (including allocated outbound and return freight) upon return of goods; (ii) promptly ship omitted items waiving Seller's new order charges. Customer is required to make timely payment to Seller of any amount, which is undisputed, or not subject to such claims.

Return of Goods for Credit

Seller accepts returns of certain Engineered Piping Products, Valve and Actuation Products, Signet Instrumentation Products, Waste and Containment Products, PVC/CPVC/HDPE Fittings and Accessories for a standard restock charge of 25%. Pipe and Custom Products are not returnable. Products denoted with a caret (^) symbol in front of the part number in the current Master Distributor Price List have a 40% restock and products denoted with an asterisk (*) symbol are non-cancelable/non-returnable. Only products purchased within the past six (6) months, in original "like new" packaging (full carton quantities), of current design, and listed in the current Master Distributor Price List shall be considered for returns. All products qualifying for return are subject to review for marketability (quantities in question in relationship to historical stock movement) before issuance of a Return Material Authorization (RMA) number. Returns due to Seller's product warranty or order entry/shipping error will not be charged a restock fee. Product for credit consideration should be returned to location designated by Seller. All returns are subject to inspection upon receipt. No credit will be issued until the returned material has been inspected, accepted, and processed. Customers will be contacted if quantity differences and/or non-acceptable material are found during inspection. Any credit issued will reflect only quantities actually received and accepted by Seller. Disposition (return to Customer or scrap) of returned product not accepted back by Seller must be provided by Customer within 10 business days, otherwise it will be subject to disposal. All material returns must be accompanied by a valid Return Material Authorization (RMA) number. RMA numbers may be obtained from the Inside Sales Department. When requesting a RMA, the original purchase order number and date of purchase must be provided. All material returns must be received within thirty (30) days of the RMA issuance. All material returns must be shipped freight prepaid and arrive to Seller's location in saleable condition. No collect shipments will be accepted by Seller. Restock charges and prepaid freight do not apply to warranty defective merchandise or returns due to Seller order entry or shipping errors.

Return of Goods for Warranty Evaluation

When requesting a RMA for material evaluation, Customer must first complete and submit a Material Safety Disclosure sheet and Request For Evaluation form obtained from Customer Service. Material arriving to Seller without a valid RMA number will be returned to the customer/distributor, freight collect. RMA numbers must be clearly referenced on all shipping documents and shipping containers.

Technical Documentation and Intellectual Property

Unless specified otherwise, technical documents such as drawings, descriptions, illustrations and the like constitute only an approximate guide. Seller reserves the right to make any changes considered necessary. Seller expressly reserves any and all intellectual property rights therein.

Warranty and Limitations

Seller's Products are carefully inspected for manufacturing defects; however, it is not always possible to detect hidden defects.

Seller warrants that its products and/or services shall conform to the description of such products or services as provided to Customer by Seller through Seller's catalog, analytical data or other literature. **THIS WARRANTY IS EXCLUSIVE, AND SELLER MAKES NO OTHER WARRANTY, EXPRESS OR IMPLIED, INCLUDING ANY IMPLIED WARRANTY OF MERCHANTABILITY OR FITNESS FOR ANY PARTICULAR PURPOSE OR COURSE OF DEALING OR USAGE OF TRADE – WHICH ARE HEREBY DISCLAIMED.**

Seller's warranties made in connection with the sale of Products shall not be effective if Seller has determined, in its sole discretion, that Customer has misused the products in any manner, has failed to use the products in accordance with industry standards and practices, or has failed to use the products in accordance with instructions, if any, furnished by Seller. Seller does not warrant any Products or Services obtained through an unauthorized Distributor, Dealer, or Agent.

Limitations of Remedy

Seller's sole and exclusive liability and Customer's exclusive remedy with respect to products proved to Seller's satisfaction to be defective or nonconforming shall be repair or replacement of such products without charge or refund of the purchase price, in Seller's sole discretion, upon the return of such products in accordance with Seller's instructions. **SELLER SHALL NOT IN ANY EVENT BE LIABLE FOR INDIRECT, DIRECT, INCIDENTAL, CONSEQUENTIAL OR SPECIAL DAMAGES OF ANY KIND RESULTING FROM ANY USE OR FAILURE OF THE PRODUCTS, OR IN CONNECTION WITH ANY SERVICES, EVEN IF SELLER HAS BEEN ADVISED OF THE POSSIBILITY OF SUCH DAMAGE INCLUDING, WITHOUT LIMITATION, LIABILITY FOR LOSS OF USE, LOSS OF WORK IN PROGRESS, DOWN TIME, LOSS OF REVENUE OR PROFITS, FAILURE TO REALIZE SAVINGS, LOSS OF PRODUCTS OF CUSTOMER OR OTHER USE, ANY LIABILITY OF CUSTOMER TO A THIRD PARTY ON ACCOUNT OF SUCH LOSS, OR FOR ANY OTHER EXPENSE, DAMAGE OR LOSS OCCASIONED BY SUCH PRODUCT OR SERVICE, INCLUDING PERSONAL INJURY OR PROPERTY DAMAGE.**

Any and all claims of Customer against Seller must be brought within one (1) year of Seller's tender of delivery, regardless of their nature.

Services

In the event Seller provides any technical or other information, advice, suggestions, assistance, work, training, or services of any kind to Buyer ("Services"), whether or not for a fee, **SELLER MAKES NO WARRANTIES, EXPRESS OR IMPLIED, ORAL OR WRITTEN, WITH RESPECT TO SUCH SERVICES, EXCEPT AS STATED IN THESE TERMS AND CONDITIONS.** The willingness of Seller to provide the Services is based upon Buyer's acceptance of and agreement to the terms, conditions, and obligations set forth herein and in any related Service Agreement signed by Buyer.

Welder Certifications

Training and certifications, for example, Level I, II, III (Welder Certifications) are provided based on the agreement of Buyer to follow and conform to all instructions, recommendations, and requirements of such certifications and related training. Buyer shall indemnify, defend and forever hold Seller and its directors, officers, employees, agents, suppliers, parents, affiliates, subsidiaries, successors and assigns harmless from any and all fines, penalties, suits, actions, claims, liabilities, judgments, costs, and expenses (including reasonable attorneys' fees) resulting or arising from the acts or omissions of Buyer, its directors, officers, employees, agents, suppliers, customers, parents, affiliates, subsidiaries, successors and assigns (all collectively referred to herein as "Buyer") related to or arising from Welder Certifications, or the performance of any related work by Buyer. The foregoing shall apply, but shall not be limited to, injury to person (including death) or damage or harm to property or the environment. Buyer shall not be obligated to indemnify Seller for any fine, penalty, suit, action, claim, liability, judgment, cost, or expense to the extent attributable to Seller's negligence or willful misconduct.

Export Law Compliance

Buyer represents that Products will not be diverted, transshipped, exported or re-exported to any country whatsoever, except in accordance with all applicable United States laws and regulations, including, but not limited to the Export Administration Act of 1979, and the regulations issued thereunder.

EU GDPR Compliance

Seller affiliates are subject to the European Union's General Data Privacy Regulation [Regulation (EU) 2016/679] (the "GDPR") when acting as a controller or processor of personal data of an individual data subject located in the European Union, as those terms are defined in the GDPR. Buyer acknowledges and agrees that it may be acting as a processor of personal data for Seller or its affiliates under these Terms and Conditions and that all applicable requirements of the GDPR are incorporated by reference herein. Buyer represents and warrants that (1) it is aware of and understands its compliance obligations under GDPR; (2) it will process personal data received from Seller or its affiliates only in accordance with Seller instructions and only in compliance with GDPR; and (3) with regard to its obligations under these Terms and Conditions it shall comply with all applicable requirements of the GDPR to the same extent as required for Seller.

Assignment

Customer may not assign its rights under or interest in any purchase order without the prior written consent of Seller. These terms and conditions of sale shall be binding upon and inure to the benefit of Customer and Seller, their successors and permitted assigns.

Applicable Law

The sale and purchase of Products and/or Services shall be governed by, and these terms and conditions shall be interpreted in accordance with the laws of the State where the Products purchased hereunder are manufactured or Services purchased hereunder are performed. All disputes hereunder shall be resolved in courts of competent jurisdiction located within the State where the Products sold or Services performed hereunder are manufactured or performed. The parties hereby waive the right to trial by jury.

Relationship of the Parties

The relationship between the parties shall be that of Seller and independent contractor. Neither Party shall be the agent of the other or have authority to act on behalf of the other party, except in a manner and to the extent provided herein or otherwise agreed to in writing. There is no special relationship between the parties or between Seller and any customer of Buyer. This Agreement creates a contractual relationship among the parties hereto, and creates no other relationship, including but not limited to a franchise, partnership, joint venture, agency, or any form of fiduciary or special relationship. Buyer agrees that it will never represent itself to third parties as having any relationship with Seller other than that of independent contractor.

Entire Agreement

These terms and conditions constitute the entire and complete agreement between Seller and Buyer concerning the sale and purchase of Products or Services. Neither party shall claim any modification, amendment or release from any of these terms and conditions unless the parties have entered into a mutual agreement to that effect, signed by Buyer and Seller.

Worldwide at home

Our sales companies and representatives ensure local customer support in over 100 countries.

Argentina / Southern South America

Georg Fischer Central Plastics
Sudamérica S.R.L.
Buenos Aires, Argentina
Phone +54 11 4512 02 90
gfcentral.ps.ar@georgfischer.com
www.gfps.com/ar

Australia

George Fischer Pty Ltd
Riverwood NSW 2210 Australia
Phone +61 (0) 2 9502 8000
australia.ps@georgfischer.com
www.gfps.com/au

Austria

Georg Fischer
Rohrleitungssysteme GmbH
3130 Herzogenburg
Phone +43 (0) 2782 856 43-0
austria.ps@georgfischer.com
www.gfps.com/at

Belgium / Luxembourg

Georg Fischer NV/SA
1070 Bruxelles/Brüssel
Phone +32 (0) 2 556 40 20
be.ps@georgfischer.com
www.gfps.com/be

Brazil

Georg Fischer Sist. de Tub. Ltda.
04795-100 São Paulo
Phone +55 (0) 11 5525 1311
br.ps@georgfischer.com
www.gfps.com/br

Canada

Georg Fischer Piping Systems Ltd
Mississauga, ON L5T 2B2
Phone +1 (905) 670 8005
Fax +1 (905) 670 8513
ca.ps@georgfischer.com
www.gfps.com/ca

China

Georg Fischer Piping Systems Ltd
Shanghai 201319
Phone +86 21 3899 3899
china.ps@georgfischer.com
www.gfps.com/cn

Denmark / Iceland

Georg Fischer A/S
2630 Taastrup
Phone +45 (0) 70 22 19 75
info.dk.ps@georgfischer.com
www.gfps.com/dk

Finland

Georg Fischer AB
01510 VANTAA
Phone +358 (0) 9 586 58 25
Fax +358 (0) 9 586 58 29
info.fi.ps@georgfischer.com
www.gfps.com/fi

France

Georg Fischer SAS
95932 Roissy Charles de Gaulle Cedex
Phone +33 (0) 1 41 84 68 84
fr.ps@georgfischer.com
www.gfps.com/fr

Germany

Georg Fischer GmbH
73095 Albershausen
Phone +49 (0) 7161 302-0
info.de.ps@georgfischer.com
www.gfps.com/de

India

Georg Fischer Piping Systems Ltd
400 076 Mumbai
Phone +91 224007 2001
branchoffice@georgfischer.com
www.gfps.com/in

Indonesia

George Fischer Pte Ltd –
Representative Office
Phone +62 21 2900 8564
Fax +62 21 2900 8566
sgp.ps@georgfischer.com
www.gfps.com/sg

Italy

Georg Fischer S.p.A.
20063 Cernusco S/N (MI)
Phone +39 02 921 861
it.ps@georgfischer.com
www.gfps.com/it

Japan

Georg Fischer Ltd
556-0011 Osaka,
Phone +81 (0) 6 6635 2691
jp.ps@georgfischer.com
www.gfps.com/jp

Korea

GF Piping Systems
Georg Fischer Korea Co., Ltd.
Unit 2501, U-Tower
120 HeungdeokJungang-ro (Yeongdeok-dong),
Giheung-gu, Yongin-si, Gyeonggi-do, Korea
Phone: +82 31 8017 1450
Fax: +82 31 217 1454
kor.ps@georgfischer.com
www.gfps.com/kr

Malaysia

George Fischer (M) Sdn. Bhd.
No. 2, 4 & 6, Jalan Permata 3/KS 09
Taman Perindustrian Air Hitam
41200 Klang, Selangor Darul Ehsan
Phone +60 (0) 3 3122 5585
Fax +603 3122 5575
my.ps@georgfischer.com
www.gfps.com/my

Mexico / Northern Latin America

Georg Fischer S.A. de C.V.
Apodaca, Nuevo Leon
CP66636 Mexico
Phone +52 (81) 1340 8586
Fax +52 (81) 1522 8906
mx.ps@georgfischer.com
www.gfps.com/mx

Middle East

Georg Fischer
Piping Systems (Switzerland) Ltd
Dubai, United Arab Emirates
Phone +971 4 289 49 60
gcc.ps@georgfischer.com
www.gfps.com/int

Netherlands

Georg Fischer N.V.
8161 PA Epe
Phone +31 (0) 578 678 222
nl.ps@georgfischer.com
www.gfps.com/nl

Norway

Georg Fischer AS
1351 Rud
Phone +47 67 18 29 00
no.ps@georgfischer.com
www.gfps.com/no

Philippines

George Fischer Pte Ltd
Representative Office
Phone +632 571 2365
Fax +632 571 2368
sgp.ps@georgfischer.com
www.gfps.com/sg

Poland

Georg Fischer Sp. z o.o.
05-090 Sekocin Nowy
Phone +48 (0) 22 31 31 0 50
poland.ps@georgfischer.com
www.gfps.com/pl

Romania

Georg Fischer
Piping Systems (Switzerland) Ltd
020257 Bucharest – Sector 2
Phone +40 (0) 21 230 53 80
ro.ps@georgfischer.com
www.gfps.com/int

Russia

Georg Fischer
Piping Systems (Switzerland) Ltd
Moscow 125047
Phone +7 495 258 60 80
ru.ps@georgfischer.com
www.gfps.com/ru

Singapore

George Fischer Pte Ltd
11 Tampines Street 92, #04-01/07
528 872 Singapore
Phone +65 6747 0611
Fax +65 6747 0577
sgp.ps@georgfischer.com
www.gfps.com/sg

Spain / Portugal

Georg Fischer S.A.
28046 Madrid
Phone +34 (0) 91 781 98 90
es.ps@georgfischer.com
www.gfps.com/es

Sweden

Georg Fischer AB
117 43 Stockholm
Phone +46 (0) 8 506 775 00
info.se.ps@georgfischer.com
www.gfps.com/se

Switzerland

Georg Fischer
Rohrleitungssysteme (Schweiz) AG
8201 Schaffhausen
Phone +41 (0) 52 631 30 26
ch.ps@georgfischer.com
www.gfps.com/ch

Taiwan

Georg Fischer Co., Ltd
San Chung Dist., New Taipei City
Phone +886 2 8512 2822
Fax +886 2 8512 2823
www.gfps.com/tw

United Kingdom / Ireland

Georg Fischer Sales Limited
Coventry, CV2 2ST
Phone +44 (0) 2476 535 535
uk.ps@georgfischer.com
www.gfps.com/uk

USA / Caribbean

Georg Fischer LLC
9271 Jeronimo Road
92618 Irvine, CA
Phone +1 714 731 88 00
Fax +1 714 731 62 01
us.ps@georgfischer.com
www.gfps.com/us

International

Georg Fischer
Piping Systems (Switzerland) Ltd
8201 Schaffhausen/Switzerland
Phone +41 (0) 52 631 30 03
Fax +41 (0) 52 631 28 93
info.export@georgfischer.com
www.gfps.com/int

The technical data are not binding. They neither constitute expressly warranted characteristics nor guaranteed properties nor a guaranteed durability. They are subject to modification. Our General Terms of Sale apply.